



TADANO ROUGH TERRAIN CRANE

MODEL : **GR-800EX**

(Left-hand steering)

GENERAL DATA

<u>CRANE CAPACITY</u>		80,000 kg at 3.0 m
<u>BOOM</u>		5-section, 12.0 m — 47.0 m
<u>DIMENSION</u>		
Overall length	approx.	14,375 mm
Overall width	approx.	3,315 mm
Overall height	approx.	3,795 mm
<u>MASS</u>		
Gross vehicle mass	approx.	51,410 kg
-front axle	approx.	24,325 kg
-rear axle	approx.	27,085 kg
<u>PERFORMANCE</u>		
Max. traveling speed	computed	25 km/h
Gradeability (tan θ)	computed	94 % (at stall) *57 %

* Machine should be operated within the limit of engine crankcase design (30° : Cummins QSB6.7).

Specifications are subject to change without notice.

CRANE SPECIFICATIONS

<u>MODEL</u>	GR-800EX
<u>CAPACITY</u>	80,000 kg at 3.0 m
<u>BOOM</u>	<p>Five section full power partially synchronized telescoping boom of round box construction with 6 sheaves at boom head. The synchronization system consists of 2 telescope cylinders, extension cables and retraction cables.</p> <p>Hydraulic cylinders fitted with holding valves.</p> <p>Fully retracted length. 12.0 m</p> <p>Fully extended length. 47.0 m</p> <p>Extension speed. 35.0 m in 160 s</p>
<u>JIB</u>	<p>Two staged swingaround boom extension. Triple offset (3.5°/25°/45°) type. Stows alongside base boom section.</p> <p>Assistant cylinders for mounting and stowing.</p> <p>Single sheave at jib head.</p> <p>Length. 10.1 m and 17.7 m</p>
<u>SINGLE TOP (AUXILIARY BOOM SHEAVE)</u>	<p>Single sheave.</p> <p>Mounted to main boom head for single line work.</p>
<u>ELEVATION</u>	<p>By a double-acting hydraulic cylinder, fitted with holding valve.</p> <p>Automatic speed reduction and slow stop function.</p> <p>Boom angle -1.5° to 80.5°</p> <p>Boom raising speed 20° to 60° in 46 s</p>
<u>HOIST - Main winch</u>	<p>Variable speed type with grooved drum driven by hydraulic axial piston motor through winch speed reducer. Power load lowering and hoisting. Equipped with automatic brake (Neutral brake) and counterbalance valve. Controlled independently of auxiliary winch.</p> <p>Single line pull. 64.7 kN {6,600 kgf}</p> <p>Single line speed(High). 149 m/min (at the 4th layer)</p> <p>Single line speed(Low) 107 m/min (at the 4th layer)</p> <p>Wire rope. No-spin type</p> <p>Diameter x length. 19 mm x 250 m</p>
<u>HOOK BLOCK(Optional) - 80 t capacity</u>	7 sheaves, swivel type hook with safety latch.
<u>HOOK BLOCK(Optional) - 35 t capacity</u>	3 sheaves, swivel type hook with safety latch.

HOIST -Auxiliary winch

Variable speed type with grooved drum driven by hydraulic axial piston motor through winch speed reducer. Power load lowering and hoisting. Equipped with automatic brake (Neutral brake) and counterbalance valve. Controlled independently of main winch.

Single line pull. 64.7 kN {6,600 kgf}

Single line speed(High). 149 m/min (at the 4th layer)

Single line speed(Low) 107 m/min (at the 4th layer)

Wire rope. No-spin type

Diameter x length. 19 mm x 139 m

HOOK BLOCK -6.6 t capacity

Swivel hook with safety latch for single line use.

SWING

Hydraulic axial piston motor driven through planetary speed reducer.

Continuous 360° full circle swing on ball bearing slew ring.

Equipped with manually locked/released swing brake.

Swing speed. 1.5 min⁻¹ {rpm}

HYDRAULIC SYSTEM

Pumps. Two variable piston pumps for telescoping, elevating and winches.

Tandem gear pump for steering, swing and optional equipment.

Control valves. . . . Multiple valves actuated by pilot pressure with integral pressure relief valves.

Circuit. Equipped with air cooled type oil cooler.

Oil pressure appears on AML display for main circuit.

Hydraulic oil tank capacity. . .

approx. 840 liters

Filters. Return line filter

CRANE CONTROL

By 4 control levers for swing, boom hoist, main winch, boom telescoping or auxiliary winch with 2 control pedals for boom hoist and boom telescoping based on ISO standard layout. Control lever stands can change neutral positions and tilt for easy access to cab.

CAB

Both crane and drive operations can be performed from one cab mounted on rotating superstructure. One sided one-man type, steel construction with sliding door access and tinted safety glass windows opening at side. Door window is powered control. Operator's 3 way adjustable seat with headrest and armrest. Air conditioner (Hot water heater and cooler).

TADANO Automatic
Moment Limiter
(Model: AML-C)

Main unit in crane cab gives audible and visual warning of approach to overload. Automatically cuts out crane motions before overload. With working range (load radius and/or boom angle and/or tip height and/or swing range) limit function. Automatic Speed Reduction and Slow Stop function on boom elevation and swing.

Following functions are displayed.

- Load as percentage
- Number of parts of line of rope
- Boom angle
- Boom length
- Load radius
- Outriggers position
- On-tire indicator
- Actual hook load
- Permissible load
- Boom position indicator
- Potential hook height
- Swing angle
- Main hydraulic oil pressure
- Jib length and jib offset angle (only when jib operation)

OUTRIGGERS

Hydraulically operated H-type outriggers. Each outrigger controlled simultaneously or independently from the cab.

Equipped with sight level gauge. Floats mounted integrally with the jacks retract to within vehicle width.

All cylinders fitted with pilot check valves.

Crane operation with different extended length of each outrigger.

Equipped with extension width detector for each outrigger.

Extended width

Fully. 7,300 mm

Middle. 6,700 mm

Middle. 5,500 mm

Minimum. 2,700 mm

Float size (Diameter). 600 mm

COUNTERWEIGHT

Integral with swing frame (containing weight with auxiliary winch and wire rope)

Mass. 9,980kg

NOTE : Each crane motion speed is based on unladen conditions.

CARRIER SPECIFICATIONS

<u>TYPE</u>	Rear engine, left hand steering, driving axle 2-way selected type (by manual switch). 4 x 2 front drive 4 x 4 front and rear drive
<u>FRAME</u>	High-tensile steel, all welded mono-box construction.
<u>ENGINE</u>	Model. . . . Cummins QSB6.7 [EUROMOT Stage B] Type. . . . 4 cycle, turbo charged and after cooled, 6 cylinder in line, direct injection, water cooled diesel engine. Piston displacement. . . . 6,700 cm ³ Bore x stroke. 107 mm x 124 mm Max. output. 194 kW at 2,500 min ⁻¹ {rpm} Max. torque. 843 N-m at 1,600 min ⁻¹ {rpm}
<u>TRANSMISSION</u>	Electronically controlled full automatic transmission. Torque converter driving full powershift with driving axle selector. 6 forward and 2 reverse speeds. 3 speeds - High range - 2 wheel drive ; 4 wheel drive 3 speeds - Low range - 4 wheel drive
<u>AXLES</u>	Front. . . . Full floating type, steering and driving axle with planetary reduction. Rear. . . . Full floating type, steering and driving axle with planetary reduction. Non-spin differential.
<u>STEERING</u>	Hydraulic power steering controlled by steering wheel. Four steering modes available: 2-wheel front 2-wheel rear 4-wheel coordinated 4-wheel crab
<u>SUSPENSION</u>	Front. . . . Rigid mounted to the frame. Rear. . . . Pivot mounted with hydraulic lockout cylinders.
<u>BRAKE SYSTEM</u>	Service. . . Air over hydraulic disc brakes on all 4 wheels. Parking / Emergency. . . Spring applied-air released brake acting on input shaft of front axle. Auxiliary. . . Electro-pneumatic operated exhaust brake.
<u>ELECTRIC SYSTEM</u>	24 V DC. 2 batteries of 12 V - 120 Ah capacity.
<u>FUEL TANK CAPACITY</u>	300 liters
<u>TIRES</u>	Front. . . . 29.5 - 25 34PR(OR), Single x 2 Air pressure:400kPa Rear. . . . 29.5 - 25 34PR(OR), Single x 2 Air pressure:400kPa
<u>TURN RADIUS</u>	Min. turning radius (at center of extreme outer tire) 2-wheel steering. 11.9 m 4-wheel steering. 6.8 m

EQUIPMENT

STANDARD EQUIPMENT

Automatic moment limiter (AML)
 External lamp and buzzer (AML)
 Pendant type over-winding cutout
 Winch automatic fail-safe brake
 Over-unwinding prevention
 Cable follower
 Hook safety latch
 Pilot check valves
 Holding valves
 Counterbalance valves
 Hydraulic pressure relief valves
 Swing brake
 Swing lock
 Boom angle indicator
 Boom elevation foot pedal
 Boom telescoping foot pedal
 Outrigger extension width detector
 Air conditioner (Hot water heater and cooler)
 Sight level gauge
 Hydraulic oil cooler
 Electric windshield wiper and washer
 Roof window wiper and washer
 Power window (Cab door)
 Tachometer/Speedometer
 3 way adjustable cloth seat with seat belt, headrest and armrest
 Cab floor mat
 Sun visor (Front and roof)
 Automatic drive system
 Transmission neutral position engine start
 Overshift prevention
 Parking braked travel warning
 Tilt-telescope steering wheel
 Back-up alarm
 Air cleaner dust indicator
 Air dryer
 Water separator with filter
 Engine over-run alarm
 Hydraulic lockout suspension
 Non-spin differential (Rear)
 Towing eyes - front and rear
 Emergency steering
 Emergency engine stop system
 Telematics (machine data logging and monitoring system) with -
 HELLO-NET via internet (availability depends on countries)
 Winch drum rotation indicator (Audible and Visual type)
 Fuel consumption monitor
 Positive control
 Eco mode system
 Winch drum mirror
 Outrigger control box(Both side of carrier)
 2-speed hoist

OPTIONAL EQUIPMENT

Tire inflation kit
 Hook block - 80t capacity (7 sheaves, swivel type with safety latch.
 Mass : approx. 700 kg)
 Hook block - 35t capacity (3 sheaves, swivel type with safety latch.
 Mass : 450 kg)

HOISTING PERFORMANCE

Layer	Main or auxiliary hoist 0.362m drum 19mm wire rope		
	Line pulls		drum grooved lagging
	Available		
	Low	High	Total wire rope
	N(kgf)	N(kgf)	Meters
1st	89,100(9,090)	63,900(6,520)	34.2
2nd	80,700(8,230)	57,800(5,900)	71.5
3rd	73,700(7,520)	52,800(5,390)	111.8
4th	67,800(6,920)	48,600(4,960)	155.2
5th	62,800(6,410)	45,100(4,600)	201.6
6th	58,500(5,970)	41,900(4,280)	251.1
7th ¹	54,800(5,590)	39,300(4,010)	303.7

¹Seventh layer of wire rope are not recommended for hoisting operations.

RATED LIFTING CAPACITIES

EN13000

ON OUTRIGGERS FULLY EXTENDED 7.3m SPREAD																				
360° ROTATION (Unit: x 1,000kg)																				
B	12m		16.4m		20.8m			29.5m			38.3m			42.6m		47m				
	A	C	C	C	C	C	C	C	C	C	C	C	C	C	C	C				
3.0	70	80.0	75	46.6	79	40.9	78	18.2												
3.5	67	74.2	74	46.6	77	40.9	77	18.2												
4.0	64	67.0	72	46.6	76	40.9	76	18.2												
4.5	62	60.9	70	46.6	75	40.9	74	18.2												
5.0	59	55.7	68	46.6	73	38.9	73	18.2	79	18.2	78	15.1								
5.5	56	51.1	66	46.6	72	36.8	71	18.2	78	18.2	77	15.1								
6.0	53	46.2	64	45.8	70	34.9	70	18.2	77	18.2	76	15.1								
6.5	49	42.1	62	41.7	69	33.2	68	18.2	76	18.2	75	15.1								
7.0	46	38.6	60	38.3	67	31.6	67	18.2	75	18.2	75	15.1	79	15.1	79	13.0				
7.5	42	35.6	58	34.4	66	30.1	65	18.2	74	18.2	74	15.1	78	15.1	78	13.0				
8.0	38	33.0	56	31.0	64	28.1	64	18.2	73	18.2	73	15.1	78	15.1	78	12.8				
9.0	27	24.0	51	24.9	61	23.3	60	18.2	71	18.2	71	15.1	76	15.1	76	12.1	77	11.0		
10.0			46	20.2	58	19.7	57	18.2	69	18.2	69	15.0	75	14.6	75	11.3	76	11.0	79	9.5
11.0			40	16.7	54	16.3	54	18.2	67	16.6	66	14.0	74	13.8	73	10.7	75	10.7	77	9.5
12.0			34	14.0	50	13.6	50	16.4	65	14.6	64	13.2	72	13.0	72	10.1	73	10.2	76	9.5
14.0			13	10.2	42	9.9	42	12.4	60	11.2	60	11.7	69	11.3	68	9.0	71	9.3	74	9.3
16.0					32	7.3	32	9.8	55	8.6	55	10.3	65	9.1	65	8.1	68	8.5	72	8.6
18.0					16	5.5	16	7.5	50	6.7	50	8.3	62	7.2	62	7.4	65	7.7	69	7.5
20.0									44	5.3	44	6.9	58	5.8	58	6.8	62	6.6	66	6.2
22.0									38	4.2	38	5.7	54	4.7	54	5.9	59	5.4	63	5.0
24.0									30	3.3	30	4.8	50	3.8	50	5.0	56	4.5	60	4.1
26.0									20	2.5	20	4.0	46	3.0	46	4.2	52	3.8	57	3.4
28.0													41	2.4	41	3.6	48	3.1	54	2.8
30.0													36	1.9	36	3.1	44	2.6	50	2.2
32.0													29	1.5	30	2.6	40	2.2	47	1.8
34.0													22	1.1	22	2.2	35	1.8	43	1.4
36.0																	30	1.4	39	1.1
38.0																	23	1.1		
40.0																	12	0.9		
D	0																		22	
Telescoping conditions (%)																				
Telescoping mode	I, II		I	I	II	I	II	I	II	I	II	I	II	II	I, II					
2nd boom	0		50	100	0	100	0	100	0	100	0	100	0	50	100					
3rd boom	0		0	0	33	33	66	66	100	100	100	100	100	100	100					
4th boom	0		0	0	33	33	66	66	100	100	100	100	100	100	100					
Top boom	0		0	0	33	33	66	66	100	100	100	100	100	100	100					

LIFTING CAPACITIES AT ZERO DEGREE BOOM ANGLE ON OUTRIGGERS FULLY EXTENDED																				
7.3m SPREAD 360° ROTATION																				
C	12.0m		16.4m		20.8m			29.5m			38.3m			42.6m						
	A	B	B	B	B	B	B	B	B	B	B	B	B	B	B	B				
0°	9.8	20.3	14.1	10.0	18.4	5.2	18.4	7.2	27.2	2.2	27.0	3.7	35.8	0.8	35.0	2.1	40.0	0.9		
Telescoping mode	I, II		I	I	II	I	II	I	II	I	II	I	II	II						

- A : Boom length(m)
- B : Load radius(m)
- C : Loaded boom angle (°)
- D : Minimum boom angle (°) for indicated length (no load)

RATED LIFTING CAPACITIES

EN13000

ON OUTRIGGERS FULLY EXTENDED 7.3m SPREAD 360° ROTATION

47.0m Boom + 10.1m Jib							47.0m Boom + 17.7m Jib						
C	3.5° Tilt		25° Tilt		45° Tilt		C	3.5° Tilt		25° Tilt		45° Tilt	
	R	W	R	W	R	W		R	W	R	W	R	W
80	10.9	4.9	14.2	4.9	16.7	4.3	80	12.8	3.1	19.1	2.9	23.8	2.3
79	11.8	4.9	15.2	4.7	17.7	4.2	79	14.1	3.1	20.5	2.8	24.7	2.3
78	12.9	4.9	16.4	4.6	18.6	4.1	78	15.5	3.1	21.7	2.7	26.0	2.3
77	14.0	4.9	17.4	4.5	19.5	4.0	77	16.9	3.1	22.7	2.7	27.0	2.3
76	15.1	4.9	18.4	4.4	20.5	3.9	76	18.1	3.1	24.1	2.6	28.0	2.2
75	16.0	4.9	19.3	4.2	21.7	3.9	75	19.4	3.1	25.2	2.6	29.0	2.2
73	18.2	4.8	21.3	4.0	23.5	3.7	73	21.9	3.1	27.3	2.5	30.0	2.2
70	21.2	4.4	24.2	3.8	26.3	3.5	70	25.6	3.1	30.4	2.4	33.8	2.1
68	23.2	4.1	26.0	3.6	28.0	3.4	68	27.8	3.0	32.4	2.3	35.7	2.1
65	26.0	3.8	28.6	3.4	30.5	3.1	65	30.8	2.7	35.3	2.2	38.1	2.0
63	27.8	3.2	30.2	2.9	31.9	2.7	63	32.7	2.3	36.9	2.0	39.6	1.8
60	30.0	2.5	32.4	2.3	33.9	2.2	60	35.2	1.7	39.3	1.5	41.9	1.4
58	31.7	2.1	34.0	2.0	35.2	1.9	58	36.7	1.4	40.8	1.3	43.0	1.2
55	33.9	1.6	35.9	1.5	37.0	1.5	55	39.2	1.0	43.3	0.9		
53	35.3	1.4	37.2	1.3	38.4	1.2							
50	37.4	1.0	39.3	1.0	40.2	0.9							

ON OUTRIGGERS FULLY EXTENDED 7.3m SPREAD 360° ROTATION

42.6m Boom(telescoping mode II) + 10.1m Jib							42.6m Boom(telescoping mode II) + 17.7m Jib						
C	3.5° Tilt		25° Tilt		45° Tilt		C	3.5° Tilt		25° Tilt		45° Tilt	
	R	W	R	W	R	W		R	W	R	W	R	W
80	9.4	5.3	13.4	5.2	15.6	4.6	80	11.5	3.3	18.5	3.0	22.6	2.4
79	10.4	5.3	14.3	5.1	16.5	4.5	79	12.6	3.3	19.6	2.9	23.4	2.3
78	11.3	5.3	15.3	5.0	17.5	4.4	78	13.8	3.3	20.4	2.8	24.5	2.3
77	12.4	5.3	16.3	4.8	18.3	4.3	77	15.1	3.3	21.3	2.8	25.5	2.3
76	13.5	5.3	17.2	4.7	19.2	4.2	76	16.3	3.3	22.3	2.7	26.4	2.3
75	14.5	5.3	18.1	4.6	19.9	4.1	75	17.5	3.3	23.3	2.7	27.3	2.3
73	16.5	5.2	19.8	4.3	21.6	4.0	73	19.6	3.3	25.4	2.6	28.9	2.2
70	19.2	4.7	22.5	4.0	23.9	3.7	70	23.0	3.3	28.3	2.5	31.5	2.1
68	21.1	4.5	24.1	3.9	25.5	3.6	68	25.2	3.3	30.1	2.4	33.1	2.1
65	23.5	4.1	26.4	3.6	27.6	3.4	65	28.1	3.0	32.8	2.3	35.4	2.1
63	25.2	3.9	28.0	3.5	29.1	3.3	63	30.2	2.9	34.6	2.3	36.9	2.0
60	27.5	3.5	30.2	3.2	31.1	3.0	60	32.7	2.6	36.9	2.2	39.2	2.0
58	28.9	3.1	31.6	2.9	32.4	2.7	58	34.3	2.2	38.4	2.0	40.4	1.9
55	31.1	2.6	33.6	2.4	34.3	2.3	55	36.7	1.8	40.6	1.7	42.2	1.6
53	32.5	2.3	34.8	2.1	35.3	2.0	53	38.0	1.6	41.7	1.4	43.4	1.4
50	34.4	1.9	36.5	1.8	37.0	1.7	50	40.2	1.3	43.7	1.2	45.0	1.1
48	35.7	1.7	37.7	1.6	38.1	1.5	48	41.6	1.1	45.0	1.0	46.0	1.0
45	37.5	1.4	39.3	1.3	39.5	1.3							
43	38.6	1.2	40.4	1.1									
40	40.3	1.0	41.9	0.9									

ON OUTRIGGERS FULLY EXTENDED 7.3m SPREAD 360° ROTATION

38.3m Boom(telescoping mode I) + 10.1m Jib							38.3m Boom(telescoping mode I) + 17.7m Jib						
C	3.5° Tilt		25° Tilt		45° Tilt		C	3.5° Tilt		25° Tilt		45° Tilt	
	R	W	R	W	R	W		R	W	R	W	R	W
80	8.4	6.6	12.5	6.4	14.7	4.9	80	10.5	4.0	17.1	3.2	20.8	2.4
79	9.3	6.6	13.4	6.2	15.5	4.8	79	11.6	4.0	18.0	3.1	21.7	2.3
78	10.3	6.6	14.1	6.0	16.3	4.7	78	12.7	4.0	19.0	3.0	22.6	2.3
77	11.2	6.6	15.1	5.9	17.1	4.7	77	13.7	4.0	19.9	3.0	23.5	2.3
76	12.1	6.6	15.8	5.7	18.0	4.6	76	14.8	4.0	20.7	2.9	24.4	2.3
75	13.0	6.6	16.6	5.6	18.6	4.6	75	15.9	4.0	21.7	2.9	25.2	2.3
73	14.9	6.6	18.2	5.4	20.1	4.5	73	18.0	4.0	23.5	2.8	26.8	2.2
70	17.4	6.2	20.6	5.1	22.3	4.4	70	20.8	3.8	26.1	2.6	29.1	2.1
68	19.0	5.9	22.1	4.9	23.6	4.4	68	22.7	3.6	27.8	2.6	30.7	2.1
65	21.4	5.5	24.3	4.7	25.7	4.3	65	25.4	3.4	30.4	2.5	32.8	2.1
63	22.8	4.8	25.6	4.3	26.9	3.9	63	27.3	3.2	31.9	2.4	34.2	2.1
60	24.9	3.9	27.3	3.5	28.7	3.3	60	29.8	2.8	34.2	2.3	36.2	2.0
58	26.2	3.4	28.6	3.1	29.8	2.9	58	31.2	2.4	35.5	2.1	37.5	2.0
55	28.0	2.8	30.3	2.6	31.5	2.5	55	33.5	2.0	37.5	1.8	39.2	1.7
53	29.5	2.5	31.5	2.3	32.6	2.2	53	34.9	1.7	38.6	1.5	40.4	1.5
50	31.3	2.1	33.1	1.9	34.2	1.8	50	37.0	1.4	40.4	1.2	41.8	1.2
48	32.5	1.8	34.2	1.7	35.1	1.6	48	38.3	1.2	41.6	1.1	42.7	1.0
45	34.2	1.5	35.7	1.4	36.5	1.3	45	40.2	0.9				
43	35.3	1.3	36.7	1.2									
40	36.8	1.0	38.2	1.0									
38	37.7	0.9											

C :Loaded boom angle (°)

R :Load radius(m)

W :Rated lifting capacity(Unit: x 1,000kg)

RATED LIFTING CAPACITIES

EN13000

ON OUTRIGGERS MID EXTENDED 6.7m SPREAD																				
360° ROTATION (Unit: x 1,000kg)																				
B \ A	12m		16.4m		20.8m			29.5m			38.3m			42.6m		47m				
	C		C		C	C		C	C		C	C		C		C				
3.0	70	80.0	76	46.6	79	40.9	78	18.2												
3.5	67	72.1	74	46.6	77	40.9	77	18.2												
4.0	65	65.0	72	46.6	76	40.9	76	18.2												
4.5	62	59.0	70	46.6	75	40.9	74	18.2												
5.0	59	53.8	68	46.6	73	38.9	73	18.2	79	18.2	78	15.1								
5.5	55	49.3	66	46.6	72	36.8	71	18.2	78	18.2	77	15.1								
6.0	52	44.0	64	43.5	70	34.5	70	18.2	77	18.2	76	15.1								
6.5	49	40.0	62	38.0	69	32.0	68	18.2	76	18.2	75	15.1								
7.0	46	35.5	60	33.6	67	30.0	67	18.2	75	18.2	74	15.1	79	15.1	79	13.0				
7.5	42	31.8	58	30.1	66	27.3	65	18.2	74	18.2	74	15.1	78	15.1	78	13.0				
8.0	37	27.8	55	27.1	64	24.6	64	18.2	73	18.2	73	15.1	78	15.1	78	12.8				
9.0	27	22.0	51	21.3	61	20.4	61	18.2	71	18.2	71	15.1	76	15.1	76	12.1	77	11.0		
10.0			46	17.2	57	16.8	57	18.2	69	17.0	69	15.0	75	14.6	75	11.3	76	11.0	79	9.5
11.0			40	14.2	54	13.8	54	16.7	67	14.7	66	14.0	73	13.8	73	10.7	75	10.7	78	9.5
12.0			34	11.9	50	11.5	50	14.2	64	12.9	64	13.2	72	12.6	72	10.1	73	10.2	77	9.5
14.0			13	8.6	42	8.2	42	10.8	60	9.6	60	11.3	69	10.0	68	9.0	70	9.3	74	9.3
16.0					32	6.0	32	8.4	55	7.3	55	8.9	65	7.9	65	8.1	68	8.3	71	8.0
18.0					16	4.3	15	6.7	50	5.6	50	7.2	62	6.2	62	7.2	65	6.9	69	6.5
20.0									44	4.3	44	5.9	58	4.9	58	6.1	62	5.6	66	5.2
22.0									38	3.3	38	4.8	54	3.9	54	5.1	59	4.6	63	4.2
24.0									30	2.5	31	4.0	50	3.1	50	4.2	56	3.8	60	3.4
26.0									20	1.9	20	3.4	46	2.4	46	3.5	52	3.1	57	2.7
28.0													41	1.8	41	3.0	48	2.5	53	2.1
30.0													36	1.4	36	2.5	44	2.0	50	1.7
32.0													30	1.0	29	2.1	40	1.6	46	1.3
34.0															21	1.7	35	1.3	43	0.9
36.0																	30	1.0		
D	0												6	0	23		34			
Telescoping conditions (%)																				
Telescoping mode	I, II		I		I		II		I		II		I		II		II		I, II	
2nd boom	0		50		100		0		100		0		100		0		50		100	
3rd boom	0		0		0		33		33		66		66		100		100		100	
4th boom	0		0		0		33		33		66		66		100		100		100	
Top boom	0		0		0		33		33		66		66		100		100		100	

LIFTING CAPACITIES AT ZERO DEGREE BOOM ANGLE ON OUTRIGGERS MID EXTENDED																				
6.7m SPREAD 360° ROTATION																				
C \ A	12.0m		16.4m		20.8m			29.5m			38.3m									
	B		B		B	B		B	B					B						
0°	9.8	###	14.2	8.3	18.5	4.0	18.3	6.5	27.2	1.5	27.2	3.0					35.4	1.6		
Telescoping mode	I, II		I		I		II		I		II						II			

- A : Boom length(m)
- B : Load radius(m)
- C : Loaded boom angle (°)
- D : Minimum boom angle (°) for indicated length (no load)

RATED LIFTING CAPACITIES**EN13000****ON OUTRIGGERS MID EXTENDED 6.7m SPREAD****360° ROTATION**

C	47.0m Boom + 10.1m Jib						C	47.0m Boom + 17.7m Jib					
	3.5° Tilt		25° Tilt		45° Tilt			3.5° Tilt		25° Tilt		45° Tilt	
	R	W	R	W	R	W		R	W	R	W	R	W
80	10.8	4.9	14.3	4.9	16.7	4.3	80	12.8	3.1	19.1	2.9	23.8	2.3
79	11.9	4.9	15.4	4.7	17.8	4.2	79	14.1	3.1	20.5	2.8	24.7	2.3
78	13.0	4.9	16.4	4.6	18.8	4.1	78	15.5	3.1	21.6	2.7	26.1	2.3
77	14.1	4.9	17.6	4.5	19.8	4.0	77	16.9	3.1	22.9	2.7	27.2	2.3
76	15.2	4.9	18.5	4.4	20.8	3.9	76	18.1	3.1	24.2	2.6	28.1	2.2
75	16.1	4.9	19.6	4.2	21.9	3.9	75	19.4	3.1	25.4	2.6	29.2	2.2
73	18.3	4.8	21.5	4.0	23.6	3.7	73	21.9	3.1	27.5	2.5	31.1	2.2
70	21.2	4.4	24.3	3.8	26.4	3.5	70	25.6	3.1	30.5	2.4	33.9	2.1
68	23.1	3.9	26.0	3.5	28.0	3.2	68	27.6	2.7	32.5	2.3	35.7	2.1
65	25.7	3.0	28.2	2.7	30.2	2.5	65	30.2	2.0	35.0	1.8	37.9	1.7
63	27.4	2.5	29.9	2.3	31.6	2.2	63	32.3	1.7	36.4	1.5	39.3	1.4
60	29.9	1.9	32.3	1.8	33.8	1.7	60	34.6	1.2	38.9	1.1	41.4	1.0
58	31.4	1.6	33.8	1.5	35.1	1.4	58	36.4	1.0				
55	33.7	1.2	35.7	1.1	37.0	1.0							
53	35.1	0.9											

ON OUTRIGGERS MID EXTENDED 6.7m SPREAD**360° ROTATION**

C	42.6m Boom(telescoping mode II) + 10.1m Jib						C	42.6m Boom(telescoping mode II) + 17.7m Jib					
	3.5° Tilt		25° Tilt		45° Tilt			3.5° Tilt		25° Tilt		45° Tilt	
	R	W	R	W	R	W		R	W	R	W	R	W
80	9.3	5.3	13.3	5.2	15.7	4.6	80	11.5	3.3	18.6	3.0	22.5	2.4
79	10.4	5.3	14.3	5.1	16.5	4.5	79	12.7	3.3	19.4	2.9	23.4	2.3
78	11.5	5.3	15.2	5.0	17.4	4.4	78	13.8	3.3	20.4	2.8	24.4	2.3
77	12.5	5.3	16.2	4.8	18.4	4.3	77	15.0	3.3	21.3	2.8	25.4	2.3
76	13.6	5.3	17.2	4.7	19.1	4.2	76	16.1	3.3	22.2	2.7	26.3	2.3
75	14.5	5.3	18.1	4.6	19.9	4.1	75	17.4	3.3	23.3	2.7	27.2	2.3
73	16.4	5.2	19.7	4.3	21.6	4.0	73	19.6	3.3	25.4	2.6	29.0	2.2
70	19.2	4.7	22.3	4.0	23.9	3.7	70	23.0	3.3	28.2	2.5	31.4	2.1
68	21.1	4.5	24.0	3.9	25.5	3.6	68	25.3	3.3	30.3	2.4	33.1	2.1
65	23.5	4.1	26.4	3.6	27.6	3.4	65	28.1	3.0	32.7	2.3	35.3	2.1
63	25.1	3.7	27.9	3.3	28.9	3.1	63	29.8	2.7	34.7	2.2	36.8	2.0
60	27.2	3.0	29.9	2.7	30.9	2.6	60	32.1	2.1	36.5	1.8	38.8	1.7
58	28.7	2.6	31.3	2.4	32.2	2.3	58	33.8	1.8	38.0	1.6	40.1	1.5
55	30.7	2.1	33.2	1.9	34.0	1.9	55	36.2	1.4	40.0	1.2	42.0	1.2
53	32.1	1.8	34.5	1.7	35.1	1.6	53	37.7	1.2	41.4	1.1	43.1	1.0
50	34.1	1.5	36.3	1.4	36.8	1.3	50	39.8	0.9				
48	35.4	1.3	37.4	1.2	37.9	1.2							
45	37.2	1.0	39.2	1.0	39.4	0.9							

ON OUTRIGGERS MID EXTENDED 6.7m SPREAD**360° ROTATION**

C	38.3m Boom(telescoping mode I) + 10.1m Jib						C	38.3m Boom(telescoping mode I) + 17.7m Jib					
	3.5° Tilt		25° Tilt		45° Tilt			3.5° Tilt		25° Tilt		45° Tilt	
	R	W	R	W	R	W		R	W	R	W	R	W
80	8.4	6.6	12.5	6.4	14.7	4.9	80	10.5	4.0	17.0	3.2	20.8	2.4
79	9.3	6.6	13.2	6.2	15.5	4.8	79	11.6	4.0	18.1	3.1	21.7	2.3
78	10.3	6.6	14.1	6.0	16.2	4.7	78	12.7	4.0	18.9	3.0	22.7	2.3
77	11.2	6.6	15.0	5.9	17.1	4.7	77	13.7	4.0	19.9	3.0	23.5	2.3
76	12.2	6.6	15.8	5.7	17.8	4.6	76	14.8	4.0	20.8	2.9	24.4	2.3
75	13.0	6.6	16.6	5.6	18.6	4.6	75	15.9	4.0	21.8	2.9	25.3	2.3
73	14.9	6.6	18.2	5.4	20.0	4.5	73	17.8	4.0	23.5	2.8	26.7	2.2
70	17.4	6.2	20.6	5.1	22.3	4.4	70	20.8	3.8	26.2	2.6	29.3	2.1
68	19.1	5.9	22.1	4.9	23.7	4.4	68	22.7	3.6	28.0	2.6	30.7	2.1
65	21.2	4.8	24.0	4.1	25.6	3.8	65	25.6	3.4	30.4	2.5	32.8	2.1
63	22.6	4.2	25.3	3.6	26.8	3.4	63	27.2	3.0	32.1	2.4	34.4	2.1
60	24.7	3.4	27.0	2.9	28.5	2.8	60	29.4	2.3	34.0	2.0	36.2	1.9
58	26.1	2.9	28.3	2.5	29.7	2.4	58	30.9	2.0	35.4	1.7	38.4	1.6
55	28.0	2.4	30.1	2.1	31.4	2.0	55	33.3	1.6	37.3	1.4	39.1	1.3
53	29.3	2.0	31.3	1.8	32.5	1.8	53	34.7	1.3	38.5	1.1	40.2	1.1
50	31.1	1.6	33.0	1.5	34.1	1.4	50	36.8	1.0				
48	32.3	1.4	34.1	1.3	35.0	1.2							
45	34.0	1.1	35.6	1.0	36.4	1.0							
43	35.1	0.9											

C :Loaded boom angle (°)

R :Load radius(m)

W :Rated lifting capacity(Unit:×1,000kg)

RATED LIFTING CAPACITIES

EN13000

ON OUTRIGGERS MID EXTENDED 5.5m SPREAD																				
360° ROTATION (Unit: x 1,000kg)																				
B	A	12m		16.4m		20.8m			29.5m			38.3m			42.6m		47m			
	C	C	C	C	C	C	C	C	C	C	C	C	C	C	C	C	C			
3.0	70	75.4	75	46.6	79	40.9	78	18.2												
3.5	67	67.0	74	46.6	77	40.9	77	18.2												
4.0	64	60.1	72	46.6	76	40.9	76	18.2												
4.5	61	52.8	70	46.6	75	40.9	74	18.2												
5.0	58	47.2	68	41.1	73	36.5	73	18.2	79	18.2	78	15.1								
5.5	55	40.3	66	35.4	72	31.6	71	18.2	78	18.2	77	15.1								
6.0	52	35.0	64	30.9	70	27.8	70	18.2	77	18.2	76	15.1								
6.5	49	30.1	62	27.3	69	24.6	68	18.2	76	18.2	75	15.1								
7.0	45	25.9	60	24.3	67	22.0	67	18.2	75	18.2	74	15.1	79	15.1	79	13.0				
7.5	42	22.6	58	21.9	66	19.8	65	18.2	74	18.2	74	15.1	78	15.1	78	13.0				
8.0	38	19.9	55	19.4	64	17.9	64	18.2	73	17.4	73	15.1	78	15.1	78	12.8				
9.0	27	15.9	51	15.3	61	14.8	61	16.7	71	14.8	71	15.1	76	14.1	76	12.1	77	11.0		
10.0			46	12.4	57	12.0	57	14.8	69	12.6	69	14.6	75	12.2	75	11.3	76	11.0	79	9.5
11.0			40	10.2	54	9.8	54	12.5	66	10.9	66	12.8	73	10.7	73	10.7	75	10.7	77	9.5
12.0			34	8.5	50	8.1	50	10.6	64	9.5	64	11.2	71	9.4	71	10.1	73	9.9	76	9.1
14.0			13	5.9	42	5.5	42	8.0	60	6.9	59	8.5	68	7.4	68	8.8	71	8.0	74	7.3
16.0					32	3.8	32	6.2	55	5.1	55	6.7	65	5.7	65	6.9	68	6.4	71	5.9
18.0					16	2.5	14	4.8	49	3.7	50	5.3	61	4.3	61	5.5	65	5.0	68	4.7
20.0									44	2.7	44	4.2	57	3.3	58	4.4	62	4.0	65	3.6
22.0									38	1.9	38	3.4	54	2.5	54	3.6	59	3.2	62	2.8
24.0									30	1.3	30	2.7	50	1.8	50	2.9	55	2.5	59	2.1
26.0											20	2.2	45	1.3	45	2.4	52	1.9	56	1.6
28.0															40	1.9	48	1.5	53	1.1
30.0															35	1.5	44	1.1		
32.0															29	1.2				
34.0															20	0.9				
D	0											35		0		29		38		
Telescoping conditions (%)																				
Telescoping mode	I, II		I	I	II		I	II	I	II	I	II	II	I, II						
2nd boom	0		50	100	0		100	0	100	0	100	0	50	100						
3rd boom	0		0	0	33		33	66	66	100	100	100	100	100						
4th boom	0		0	0	33		33	66	66	100	100	100	100	100						
Top boom	0		0	0	33		33	66	66	100	100	100	100	100						

LIFTING CAPACITIES AT ZERO DEGREE BOOM ANGLE ON OUTRIGGERS MID EXTENDED																			
5.5m SPREAD 360° ROTATION																			
C	A	12.0m		16.4m		20.8m			29.5m			38.3m							
	B	B	B	B	B	B	B	B	B	B	B	B	B	B	B	B	B		
0°	9.8	13.0	14.1	5.8	18.5	2.3	18.3	4.6	27.2	0.5	27.1	2.0			35.4	0.4			
Telescoping mode	I, II		I	I	II		I	II	I		II		II						

- A : Boom length(m)
- B : Load radius(m)
- C : Loaded boom angle (°)
- D : Minimum boom angle (°) for indicated length (no load)

RATED LIFTING CAPACITIES**EN13000****ON OUTRIGGERS MID EXTENDED 5.5m SPREAD****360° ROTATION**

C	47.0m Boom + 10.1m Jib						C	47.0m Boom + 17.7m Jib					
	3.5° Tilt		25° Tilt		45° Tilt			3.5° Tilt		25° Tilt		45° Tilt	
	R	W	R	W	R	W		R	W	R	W	R	W
80	10.7	4.9	14.2	4.9	16.8	4.3	80	12.8	3.1	19.3	2.9	23.9	2.3
79	11.9	4.9	15.4	4.7	17.8	4.2	79	14.1	3.1	20.5	2.8	24.9	2.3
78	13.0	4.9	16.5	4.6	18.8	4.1	78	15.6	3.1	21.7	2.7	26.0	2.3
77	14.0	4.9	17.6	4.5	19.8	4.0	77	16.9	3.1	22.9	2.7	27.1	2.3
76	15.2	4.9	18.6	4.4	20.8	3.9	76	18.2	3.1	24.0	2.6	28.2	2.2
75	16.3	4.9	19.5	4.2	21.9	3.9	75	19.5	3.1	23.1	2.6	29.1	2.2
73	18.3	4.2	21.5	3.5	23.6	3.3	73	22.2	2.8	27.5	2.3	31.2	2.2
70	21.2	3.1	24.2	2.7	26.4	2.5	70	25.8	2.0	30.7	1.7	33.9	1.6
68	23.2	2.5	26.1	2.2	28.0	2.1	68	27.9	1.6	32.5	1.4	35.8	1.3
65	26.1	1.8	28.7	1.6	30.5	1.6	65	31.2	1.1	35.4	0.9	38.2	0.9
63	27.8	1.5	30.2	1.3	32.0	1.3							
60	30.1	1.0											

ON OUTRIGGERS MID EXTENDED 5.5m SPREAD**360° ROTATION**

C	42.6m Boom(telescoping mode II) + 10.1m Jib						C	42.6m Boom(telescoping mode II) + 17.7m Jib					
	3.5° Tilt		25° Tilt		45° Tilt			3.5° Tilt		25° Tilt		45° Tilt	
	R	W	R	W	R	W		R	W	R	W	R	W
80	9.3	5.3	13.4	5.2	15.7	4.6	80	11.5	3.3	18.6	3.0	22.5	2.4
79	10.4	5.3	14.3	5.1	16.6	4.5	79	12.7	3.3	19.6	2.9	23.5	2.3
78	11.4	5.3	15.2	5.0	17.4	4.4	78	13.9	3.3	20.2	2.8	24.4	2.3
77	12.4	5.3	16.2	4.8	18.3	4.3	77	15.0	3.3	21.2	2.8	25.3	2.3
76	13.6	5.3	17.2	4.7	19.1	4.2	76	16.2	3.3	22.3	2.7	26.3	2.3
75	14.5	5.3	18.1	4.6	20.0	4.1	75	17.5	3.3	23.1	2.7	27.3	2.3
73	16.5	5.2	19.8	4.3	21.6	4.0	73	19.7	3.3	25.9	2.6	29.0	2.2
70	19.2	4.5	22.3	3.9	23.9	3.6	70	23.0	3.2	28.2	2.5	31.5	2.1
68	20.7	3.8	23.8	3.3	25.2	3.1	68	24.7	2.6	29.9	2.3	33.0	2.0
65	23.0	3.0	26.0	2.6	27.2	2.4	65	27.4	2.0	32.4	1.8	35.0	1.5
63	24.5	2.5	27.3	2.2	28.5	2.1	63	29.1	1.7	33.8	1.5	36.4	1.3
60	26.7	1.9	29.5	1.7	30.5	1.6	60	31.6	1.3	36.0	1.1	38.5	1.0
58	28.1	1.6	30.8	1.5	31.8	1.4	58	33.2	1.0				
55	30.3	1.2	32.8	1.1	33.7	1.1							
53	31.7	1.0											

ON OUTRIGGERS MID EXTENDED 5.5m SPREAD**360° ROTATION**

C	38.3m Boom(telescoping mode I) + 10.1m Jib						C	38.3m Boom(telescoping mode I) + 17.7m Jib					
	3.5° Tilt		25° Tilt		45° Tilt			3.5° Tilt		25° Tilt		45° Tilt	
	R	W	R	W	R	W		R	W	R	W	R	W
80	8.4	6.6	12.5	6.4	14.7	4.9	80	10.5	4.0	17.0	3.2	20.8	2.4
79	9.3	6.6	13.4	6.2	15.5	4.8	79	11.6	4.0	18.1	3.1	21.7	2.3
78	10.3	6.6	14.2	6.0	16.3	4.7	78	12.7	4.0	19.0	3.0	22.7	2.3
77	11.2	6.6	15.0	5.9	17.1	4.7	77	13.8	4.0	19.9	3.0	23.6	2.3
76	12.2	6.6	15.9	5.7	17.9	4.6	76	14.8	4.0	20.8	2.9	24.5	2.3
75	13.0	6.6	16.6	5.6	18.7	4.6	75	15.9	4.0	21.8	2.9	25.3	2.3
73	14.8	6.3	18.3	5.4	20.1	4.5	73	18.0	4.0	23.6	2.8	26.9	2.2
70	17.1	5.0	20.3	4.3	22.2	3.9	70	20.7	3.7	26.3	2.6	29.2	2.1
68	18.6	4.2	21.7	3.7	23.4	3.4	68	22.5	3.1	28.0	2.5	30.8	2.1
65	20.8	3.3	23.6	2.9	25.3	2.7	65	25.0	2.4	30.1	1.9	32.8	1.8
63	22.3	2.8	24.9	2.5	26.5	2.3	63	26.6	1.9	31.5	1.6	34.0	1.5
60	24.4	2.1	26.8	1.9	28.3	1.8	60	28.9	1.4	33.7	1.2	35.9	1.1
58	25.8	1.8	28.1	1.6	29.5	1.5	58	30.5	1.1	35.1	1.0	37.1	0.9
55	27.8	1.3	29.9	1.2	31.3	1.1							
53	28.9	1.0	31.0	1.0	32.3	0.9							

C :Loaded boom angle (°)

R :Load radius(m)

W :Rated lifting capacity(Unit:×1,000kg)

RATED LIFTING CAPACITIES

EN13000

ON OUTRIGGERS MIN EXTENDED 2.7m SPREAD																				
360° ROTATION (Unit: x 1,000kg)																				
B	12m		16.4m		20.8m			29.5m			38.3m			42.6m		47m				
	A	C	C	C	C	C	C	C	C	C	C	C	C	C	C	C				
3.0	70	33.8	75	28.9	79	20.9	78	18.2												
3.5	67	27.7	74	23.9	78	20.9	77	18.2												
4.0	64	23.3	71	20.2	76	17.8	75	18.2												
4.5	61	19.9	70	17.3	75	15.3	74	18.2												
5.0	58	17.2	68	15.0	73	13.2	73	16.1	78	12.7	78	14.6								
5.5	55	14.5	66	13.0	72	11.5	71	14.4	77	11.3	77	13.1								
6.0	52	12.3	64	11.5	70	10.1	70	12.9	76	10.1	76	11.9								
6.5	48	10.6	62	10.1	68	8.9	68	11.6	75	9.0	75	10.8								
7.0	45	9.2	60	8.7	67	7.8	67	10.5	74	8.1	74	9.9	78	7.8	79	8.5				
7.5	42	8.0	57	7.5	66	6.9	65	9.6	73	7.3	73	9.1	77	7.1	78	8.5				
8.0	38	7.0	55	6.5	64	6.1	63	8.7	72	6.6	72	8.3	77	6.5	77	7.8				
9.0	28	5.4	50	4.9	61	4.6	60	7.0	70	5.4	70	7.1	75	5.4	76	6.7	77	5.9		
10.0			46	3.7	57	3.3	57	5.7	68	4.4	68	6.1	74	4.5	74	5.8	76	5.1	78	4.4
11.0			40	2.7	54	2.3	53	4.6	66	3.6	66	5.1	72	3.8	72	5.0	74	4.4	76	3.6
12.0			34	1.9	50	1.5	49	3.8	63	2.8	63	4.3	71	3.1	71	4.4	73	3.6	75	2.9
14.0							41	2.5	59	1.6	59	3.0	67	2.0	68	3.2	70	2.5	72	1.9
16.0							32	1.6			54	2.1	64	1.1	64	2.3	67	1.7	69	1.1
18.0							12	0.9			49	1.4			61	1.6	64	1.0		
20.0															57	1.0				
D	0		12		42		0		54		43		60		53		58		63	
Telescoping conditions (%)																				
Telescoping mode	I, II		I		I		II		I		II		I		II		II		I, II	
2nd boom	0		50		100		0		100		0		100		0		50		100	
3rd boom	0		0		0		33		33		66		66		100		100		100	
4th boom	0		0		0		33		33		66		66		100		100		100	
Top boom	0		0		0		33		33		66		66		100		100		100	

LIFTING CAPACITIES AT ZERO DEGREE BOOM ANGLE ON OUTRIGGERS MIN EXTENDED												
2.7m SPREAD 360° ROTATION												
C	12.0m		16.4m		20.8m		29.5m		38.3m		42.6m	
	A	B	C	C	C	C	C	C	C	C	C	
0°	9.8	4.0			18.3	0.8						
Telescoping mode	I, II				II							

- A : Boom length(m)
- B : Load radius(m)
- C : Loaded boom angle (°)
- D : Minimum boom angle (°) for indicated length (no load)

NOTES FOR "ON OUTRIGGERS" TABLE

1. Rated lifting capacities shown in the table are based on condition that crane is set on firm level surface. Those above thick lines are based on crane strength and those below, on its stability.
2. Rated lifting capacities based on crane stability are according to EN13000.
3. The mass of the hook (700 kg for 80t capacity, 450 kg for 35t capacity, 165 kg for 6.6 t capacity), slings and all similarly used load handling devices must be considered as part of the load and must be deducted from the lifting capacities.
4. For rated lifting capacity of single top, reduce the rated lifting capacities of relevant boom according to a weight reduction for auxiliary load handling equipment. Capacities of single top shall not exceed 6,600 kg including main boom hook mass and the net capacity must be so reduced.
5. Standard number of parts of line for each boom length is as shown below. Load per line should not surpass 64.7 kN {6,600 kgf} for main winch and auxiliary winch.

Boom length	12.0m	12.0m to 20.8m		20.8m to 47.0m	Single top Jib
Telescoping mode	I, II	I	II	I, II	I, II
Number of parts of line	14	8	4	4	1

The lifting capacity data stored in the AUTOMATIC MOMENT LIMITER (AML) is based on the standard number of parts of line listed in the chart.

Maximum lifting capacity is restricted by the number of parts of line of AUTOMATIC MOMENT LIMITER (AML).

6. The lifting capacity for over-side area differs depending on the outrigger extension width. Work with the capacity corresponding to the extension width. The lifting capacities for over-front and over-rear areas are for "outriggers fully extended". However, the areas (angle a) differ depending on the outrigger extension width.

Outriggers extended width	6.7m (middle)	5.5m (middle)	2.7m (minimum)
Angle a °	60	40	15

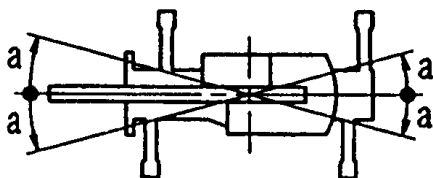

RATED LIFTING CAPACITIES
EN13000

ON-RUBBER STATIONARY (Unit: x 1,000kg)												
A	Over Front						360° Rotation					
	12m		20.8m		29.5m		12m		20.8m		29.5m	
	C	C	C	C	C	C	C	C	C	C	C	
3.5	67	28.5										
4.0	64	25.3					64	15.5				
4.5	61	23.0					61	12.9				
5.0	58	20.9					58	10.9				
5.5	55	19.0					55	9.3				
6.0	52	17.3	70	13.5			52	7.9	70	9.0		
6.5	49	15.9	68	13.5			49	6.6	68	7.8		
7.0	45	14.7	67	13.5	74	10.4	45	5.6	67	6.8		
7.5	42	13.3	65	13.5	73	10.4	42	4.7	65	6.0	73	6.8
8.0	38	12.2	63	12.6	72	10.4	38	3.8	63	5.2	72	6.0
8.5	33	11.0	62	11.7	71	10.0	33	3.3	62	4.7	71	5.2
9.0	28	10.0	60	10.8	70	9.8	28	2.8	60	4.2	70	4.6
10.0			57	9.0	68	9.3			57	3.3	68	3.5
11.0			53	7.6	66	8.3			53	2.5	66	2.8
12.0			50	6.5	64	7.2			50	2.0	63	2.2
14.0			42	4.8	59	5.3			42	1.0	59	1.5
16.0			32	3.5	54	4.1						
18.0			13	2.5	49	3.2						
20.0					44	2.5						
22.0					37	1.8						
24.0					30	1.2						
26.0					19	0.9						
D					0				31			54
Telescoping conditions (%)												
Telescoping	I, II	II	II	II	I, II	II	II					
2nd boom	0	0	0	0	0	0	0					
3rd boom	0	33	66	66	0	33	66					
4th boom	0	33	66	66	0	33	66					
Top boom	0	33	66	66	0	33	66					

LIFTING CAPACITIES AT ZERO DEGREE BOOM ANGLE ON-RUBBER STATIONARY												
A	Over Front						360° Rotation					
	12m		20.8m		29.5m		12m					
	B	B	B	B	B	B	B					
0	9.9	8.5	18.3	2.4	27.2	0.6	9.9	2.0				

ON-RUBBER CREEP (Unit: x 1,000kg)												
A	Over Front						360° Rotation					
	12m		20.8m		29.5m		12m		20.8m		29.5m	
	C	C	C	C	C	C	C	C	C	C	C	
4.0	65	19.0					64	11.2				
4.5	61	17.0					62	9.8				
5.0	58	15.1					58	8.5				
5.5	55	13.6					55	7.5				
6.0	52	12.4	70	13.5			52	6.5	69	7.5		
6.5	49	11.4	68	12.3			49	5.4	68	6.5		
7.0	45	10.3	66	11.4	74	10.4	45	4.7	67	5.8		
7.5	42	9.5	65	10.5	73	10.4	42	3.8	65	5.0	73	5.8
8.0	39	8.7	64	9.7	72	10.0	38	3.1	63	4.3	72	5.0
8.5	33	8.0	62	9.1	71	9.4	34	2.5	62	3.8	71	4.3
9.0	27	7.3	60	8.5	70	8.7	28	2.3	60	3.3	70	3.8
10.0			57	7.3	68	7.7			57	2.5	69	3.0
11.0			53	6.3	66	6.7			53	2.0	68	2.5
12.0			50	5.6	64	6.0			50	1.5	66	1.9
14.0			42	4.2	59	4.7					59	1.1
16.0			32	3.3	54	3.7						
18.0			13	2.5	49	2.6						
20.0					43	2.0						
22.0					37	1.4						
24.0					30	1.0						
D			0		19		0		38			54
Telescoping conditions (%)												
Telescoping	I, II	II	II	II	I, II	II	II					
2nd boom	0	0	0	0	0	0	0					
3rd boom	0	33	66	66	0	33	66					
4th boom	0	33	66	66	0	33	66					
Top boom	0	33	66	66	0	33	66					

LIFTING CAPACITIES AT ZERO DEGREE BOOM ANGLE ON-RUBBER STATIONARY												
A	Over Front						360° Rotation					
	12m		20.8m				12m					
	B	B	B	B		B	B					
0	9.9	6.3	18.3	2.4			9.9	1.6				

A : Boom length(m)
 B : Load radius(m)
 C : Loaded boom angle (°)
 D : Minimum boom angle (°) for indicated length (no load)

NOTES FOR "ON-RUBBER" TABLES

1. Rated lifting capacities shown in the table are based on condition that crane is set on firm level surface, with suspension lock applied. Those above thick lines are based on tire capacity and those below, on crane stability. They are based on actual load radius increased by tire deformation and boom deflection.
2. Rated lifting capacities based on crane stability are according to EN13000.
3. The mass of the hook (700 kg for 80t capacity, 450 kg for 35t capacity, 165 kg for 6.6t capacity), slings and all similarly used load handling devices must be considered as part of the load and must be deducted from the lifting capacities.
4. For rated lifting capacity of single top, reduce the rated lifting capacities of relevant boom according to weight reductions for auxiliary load handling equipment. Capacities of single top shall not exceed 6,600 kg including main hook.
5. On-rubber lifting with "jib" is not permitted. Maximum permissible boom length is 29.5 m (over front).
6. CREEP is motion for crane not to travel more than 60 m in any 30 minute period and to travel at the speed of less than 1.6 km/h.
7. During "CREEP" duties travel slowly and keep the lifting load as close to the ground as possible, and especially avoid any abrupt steering, accelerating or braking.
8. Do not operate the crane while carrying the load.
9. Tires should be inflated to their correct air pressure of 400kPa.
10. For CREEP operation, choose the drive mode and proper gear according to the road or working condition.
11. Standard number of parts of line for on-rubber operation should be according to the following table.

Load per line should not surpass 64.7 kN {6,600 kgf} for main winch and auxiliary winch.

Boom length	12.0m	12.0m to 29.5m	Single top
Telescoping mode	I, II	II	I, II
Number of parts of line	6	4	1

The lifting capacity data stowed in the AUTOMATIC MOMENT LIMITER (AML) is based on the standard number of parts of line listed in the chart.

Maximum lifting capacity is restricted by the number of parts of line of AUTOMATIC MOMENT LIMITER (AML).

WORKING AREA

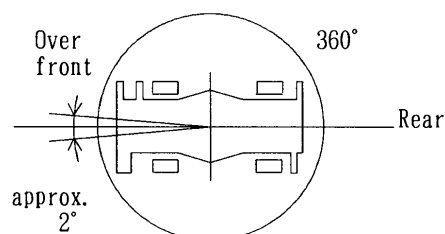

Without outriggers "Over front" operation should be performed within 2 degrees in front of chassis.

WORKING RANGE CHART

Telescoping mode I

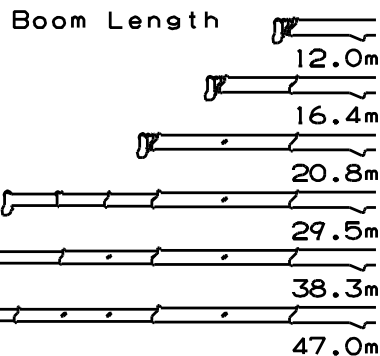
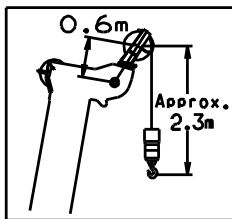
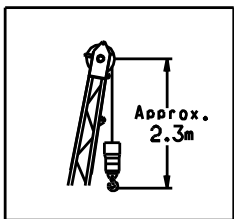
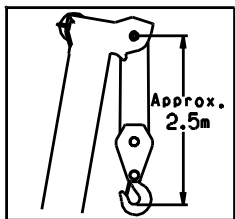
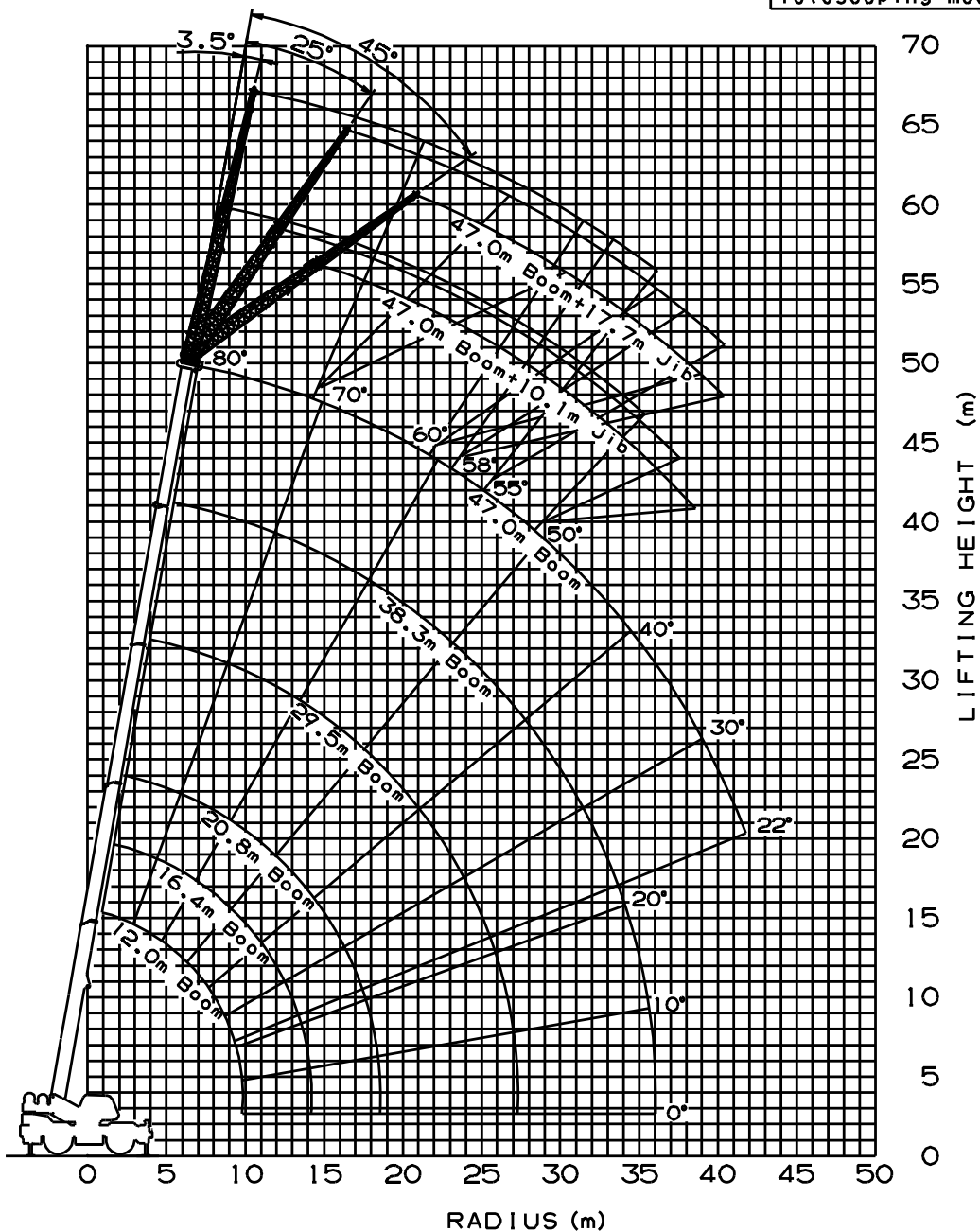

NOTE: 1. Boom and jib geometry shown are for unloaded condition and machine standing level on firm supporting surface. Boom deflection and subsequent radius and boom angle change must be accounted for when applying load to hook.

WORKING RANGE CHART

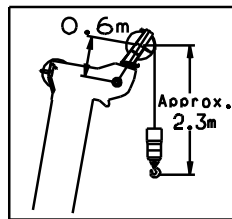
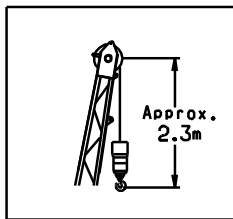
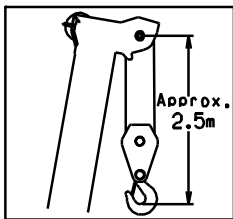
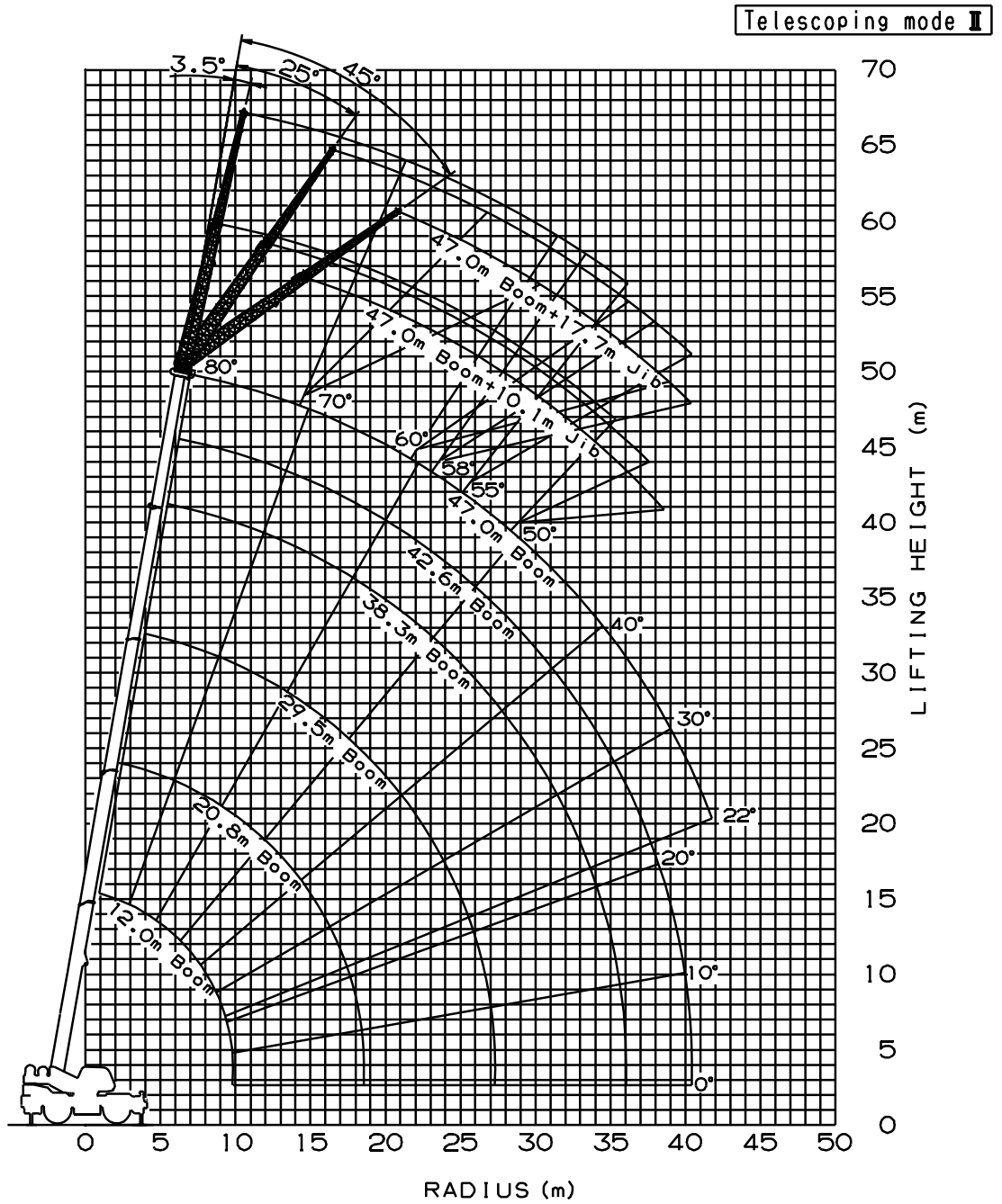

Boom Length

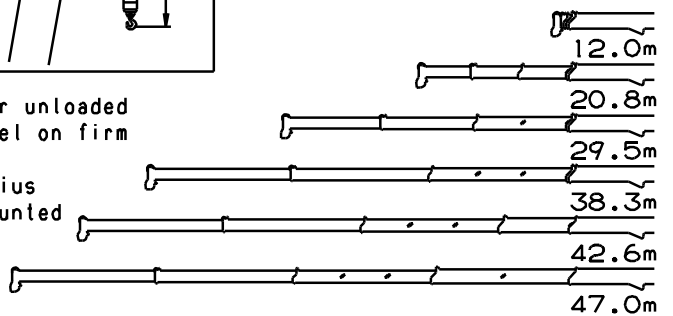

NOTE: 1. Boom and jib geometry shown are for unloaded condition and machine standing level on firm supporting surface.
 Boom deflection and subsequent radius and boom angle change must be accounted for when applying load to hook.

DIMENSIONS

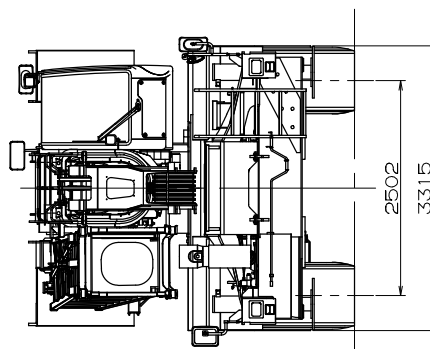
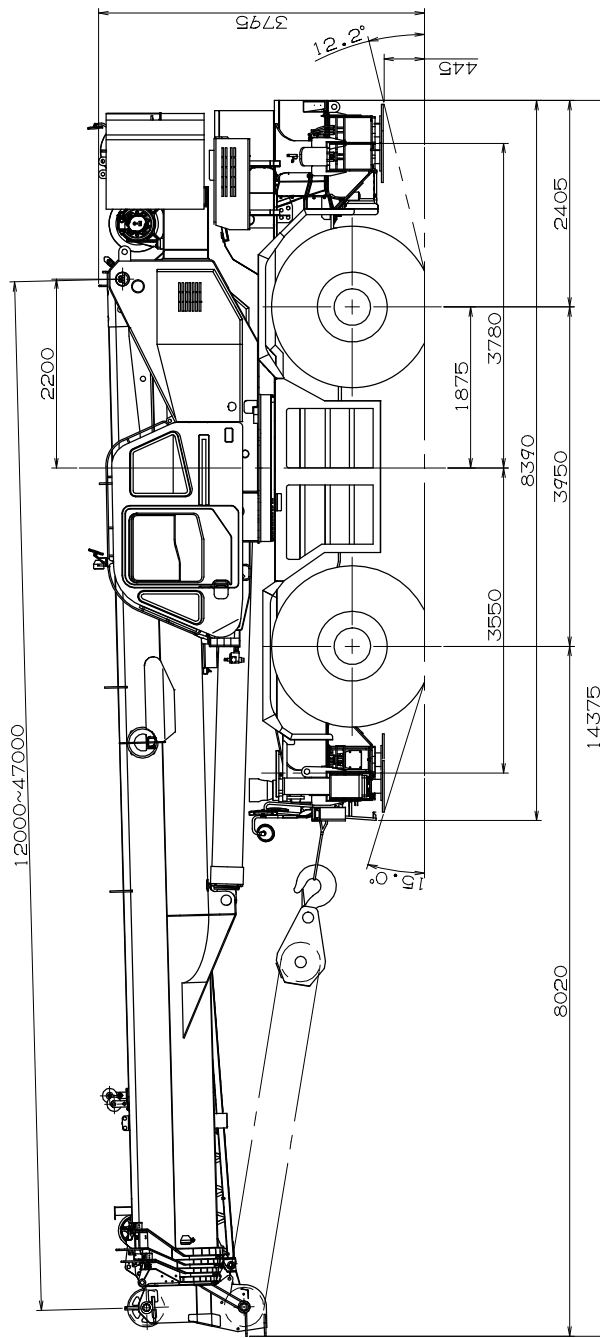
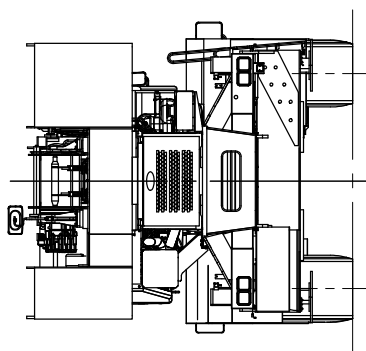
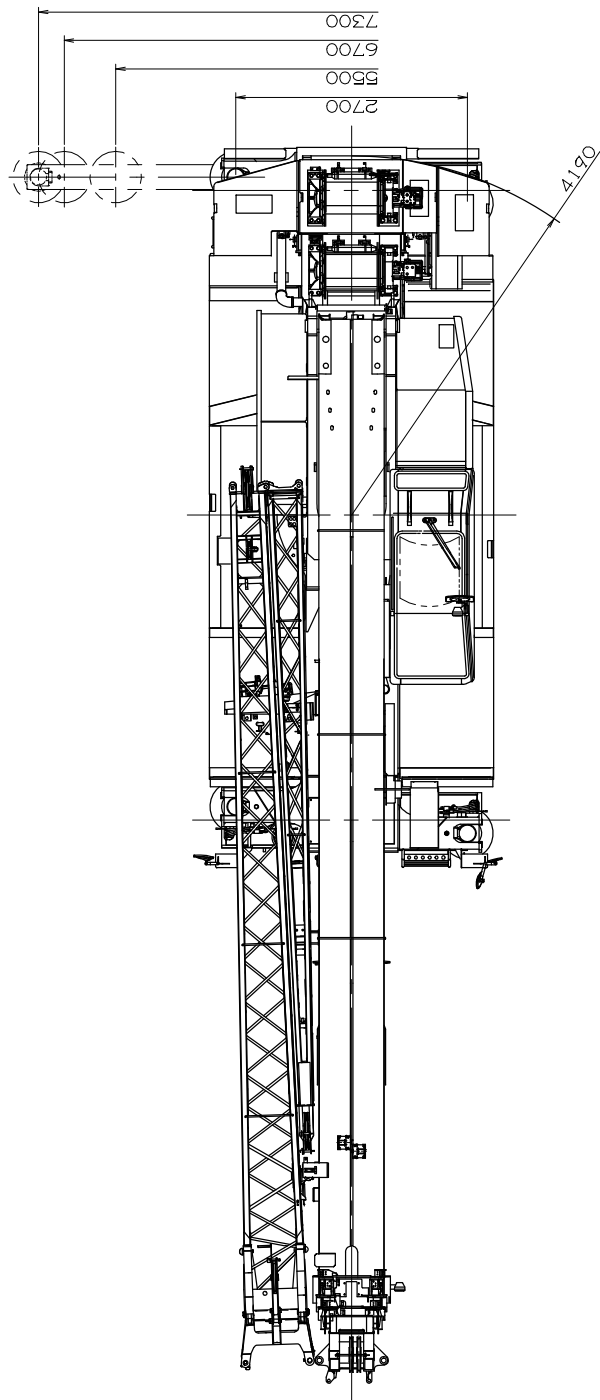

Note: Dimension is with boom angle at -1.5 degree.

GR-800EX Axle Weight Distribution Chart

UNIT : kg

	GVW	Front	Rear
Basic standard machine includes: 5-section boom (12.0 m - 47.0 m) 2-stage jib (10.1 m, 17.7 m) Single top 6.6 ton hook block	51,410	24,325	27,085
Add:			
1. 80t 7 sheaves hook block	+700	+1,350	-650
2. 35t 3 sheaves hook block	+450	+870	-420
Remove:			
1. 6.6 ton hook block	-165	-235	+70
2. Top jib	-335	-450	+115
3. Base jib	-865	-1,705	+840
4. Counter weight with auxiliary winch and wire rope	-9,980	+4,240	-14,220